



Parameter	Rating	Units
Blocking Voltage	100	V <sub>P</sub>
Load Current	2.5	A <sub>DC</sub>
On-Resistance	0.34	Ω

### Features

- Power SIP Package
- Handle Load Currents Up to 2.5A<sub>rms</sub>
- High Reliability
- No Moving Parts
- Low Drive Power Requirements (TTL/CMOS Compatible)
- Arc-Free With No Snubbing Circuits
- 2500V<sub>rms</sub> Input/Output Isolation
- No EMI/RFI Generation
- Machine Insertable, Wave Solderable

### Applications

- Industrial Controls
- Motor Control
- Robotics
- Medical Equipment—Patient/Equipment Isolation
- Instrumentation
  - Multiplexers
  - Data Acquisition
  - Electronic Switching
  - I/O Subsystems
  - Meters (Watt-Hour, Water, Gas)
- IC Equipment
- Home Appliances

### Description

Clare and IXYS have combined to bring OptoMOS® technology, reliability, and compact size to a new family of high-power, solid state relays. As part of that family, the CPC1916 is a 1-Form-A solid state relay. The CPC1916 employs optically coupled MOSFET technology to provide 2500V<sub>rms</sub> of input to output isolation. The efficient MOSFET switches and photovoltaic die use Clare's patented OptoMOS architecture, while the output is controlled by a highly efficient GaAlAs infrared LED. The combination of low on-resistance and high load-current handling capabilities makes the relay suitable for a variety of high-performance switching applications.

### Approvals

- UL Recognized Component: File # E69938
- Certified to: UL 508

### Ordering Information

Part #	Description
CPC1916Y	Power SIP Package (25 per tube)

### Pin Configuration

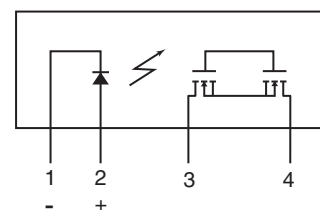

### Switching Characteristics of Normally Open (Form A) Devices

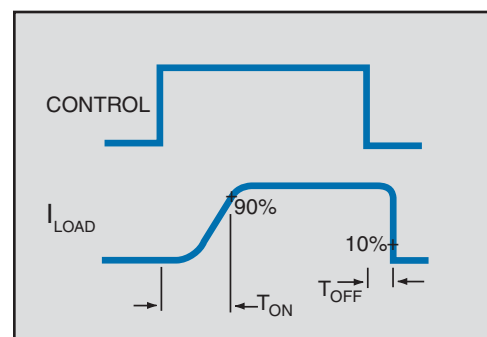

## Absolute Maximum Ratings (@ 25° C)

Parameter	Ratings	Units
Blocking Voltage	100	V <sub>P</sub>
Reverse Input Voltage	5	V
Input control Current	50	mA
Peak (10ms)	1	A
Input Power Dissipation <sup>1</sup>	150	mW
Isolation voltage Input to Output	2500	V <sub>rms</sub>
Operational Temperature	-40 to +85	°C
Storage Temperature	-40 to +125	°C

<sup>1</sup> Derate Linearly 3.33 mw / °C

Absolute Maximum Ratings are stress ratings. Stresses in excess of these ratings can cause permanent damage to the device. Functional operation of the device at conditions beyond those indicated in the operational sections of this data sheet is not implied.

## Electrical Characteristics

Parameter	Conditions	Symbol	Min	Typ	Max	Units
<b>Output Characteristics @ 25°C</b>						
Load Current, Continuous	Free air	I <sub>L</sub>	-	-	2.5	A <sub>DC</sub>
Peak Load Current	t ≤ 10ms	I <sub>L</sub>	-	-	6	A <sub>P</sub>
On-Resistance <sup>1</sup>	I <sub>L</sub> =1A	R <sub>ON</sub>	-	-	0.34	Ω
Off-State Leakage Current	V <sub>L</sub> =100V	I <sub>LEAK</sub>	-	-	1	μA
Switching Speeds						
Turn-On	I <sub>F</sub> =10mA, V <sub>L</sub> =10V	t <sub>ON</sub>	-	-	5	ms
Turn-Off		t <sub>OFF</sub>	-	-	3	
<b>Input Characteristics @ 25°C</b>						
Input Control Current	I <sub>L</sub> =1A	I <sub>F</sub>	-	-	10	mA
Input Dropout Current	-	I <sub>F</sub>	0.3	-	-	mA
Input Voltage Drop	I <sub>F</sub> =5mA	V <sub>F</sub>	0.9	1.2	1.4	V
Reverse Input Current	V <sub>R</sub> =5V	I <sub>R</sub>	-	-	10	μA
<b>Common Characteristics @ 25°C</b>						
Capacitance Input/Output	-	-	-	2	-	pF

<sup>1</sup> Measurement taken within 1 second of on time.

## Thermal Characteristics

Parameter	Conditions	Symbol	Min	Typ	Max	Units
Thermal Resistance (junction to case)	-	R <sub>θJC</sub>	-	1.5	-	°C/W

**PERFORMANCE DATA\***

**Typical LED Forward Voltage Drop**  
(N=50,  $T_A=25^\circ\text{C}$ ,  $I_F=10\text{mA}$ )

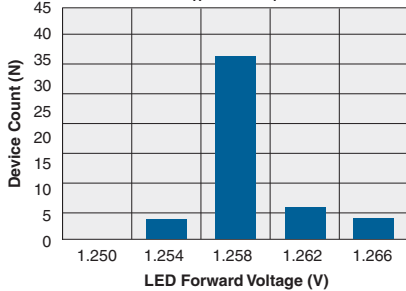

**Typical On-Resistance Distribution**  
(N=50,  $T_A=25^\circ\text{C}$ ,  $I_L=1.0A_{DC}$ ,  $I_F=10\text{mA}$ )

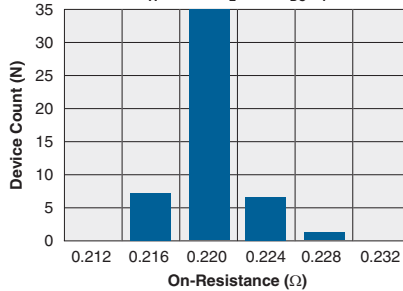

**Typical Blocking Voltage Distribution**  
(N=50,  $T_A=25^\circ\text{C}$ )

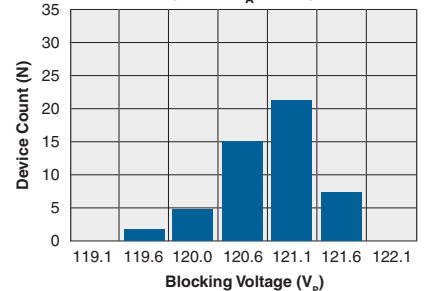

**Typical Turn-On Time**  
(N=50,  $T_A=25^\circ\text{C}$ ,  $I_L=5mA_{DC}$ ,  $I_F=10\text{mA}$ )

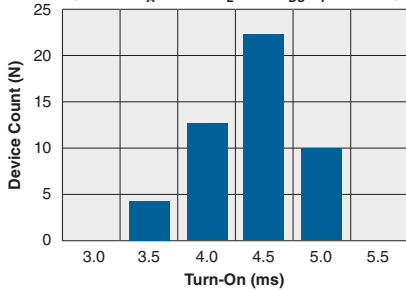

**Typical Turn-Off Time**  
(N=50,  $T_A=25^\circ\text{C}$ ,  $I_L=5mA_{DC}$ ,  $I_F=10\text{mA}$ )

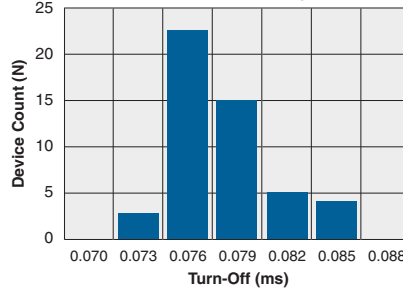

**Typical Load Current vs. Temperature**

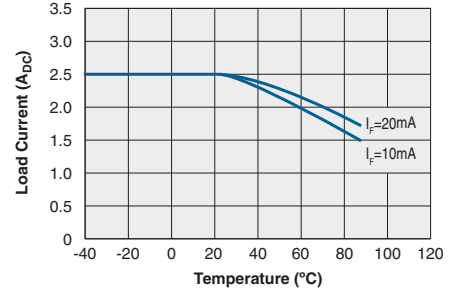

**Typical Leakage vs. Temperature at Measured across Pins 3 & 4**  
( $V_L=100\text{V}$ )

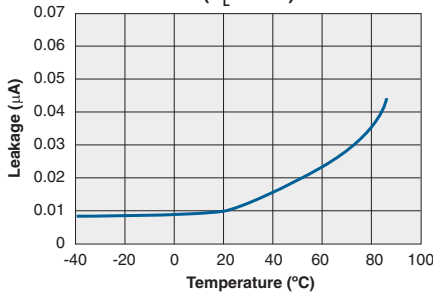

**Typical Blocking Voltage vs. Temperature**

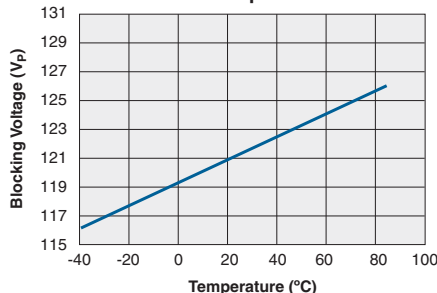

**Typical Turn-On vs. Temperature**  
( $I_L=100mA_{DC}$ )

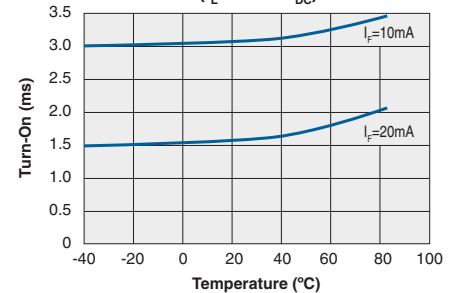

**Typical Turn-Off vs. Temperature**  
( $I_L=100mA_{DC}$ )

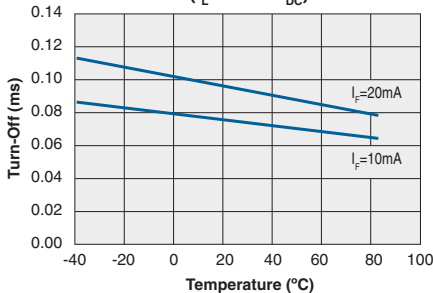

**Typical LED Forward Voltage Drop vs. Temperature**

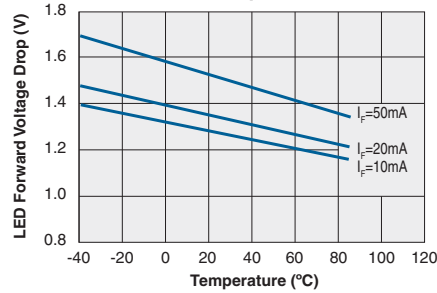

**Typical Turn-On vs. LED Forward Current**  
( $I_L=100mA_{DC}$ )

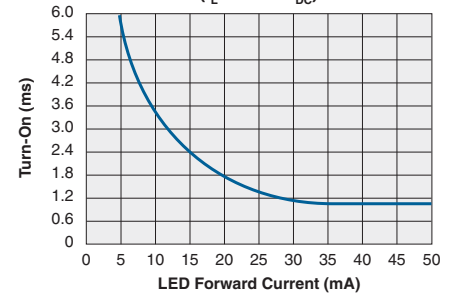

\*The Performance data shown in the graphs above is typical of device performance. For guaranteed parameters not indicated in the written specifications, please contact our application department.

**PERFORMANCE DATA\***

**Typical Turn-Off vs. LED Forward Current**  
( $I_L=100mA_{DC}$ )

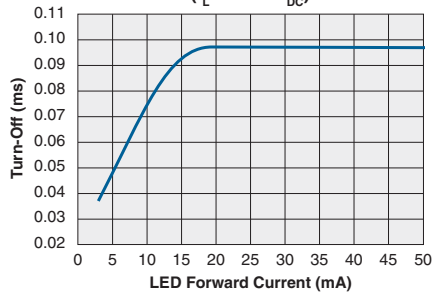

**Typical On-Resistance vs. Temperature**  
( $I_L=1.0A_{DC}, I_F=10mA$ )

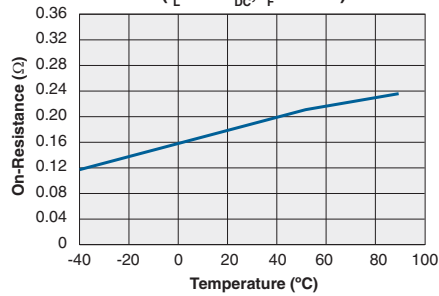

**Typical  $I_F$  for Switch Operation vs. Temperature**  
( $I_L=100mA_{DC}$ )

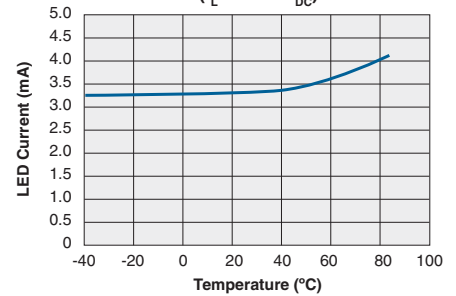

**Typical Load Current vs. Load Voltage**  
( $T_A=25°C, I_F=10mA$ )

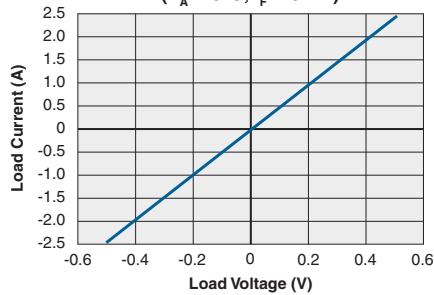

**Energy Rating Curve**  
(Free Air, No Heat Sink)

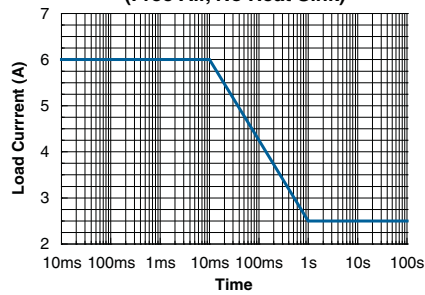

\*The Performance data shown in the graphs above is typical of device performance. For guaranteed parameters not indicated in the written specifications, please contact our application department.

**Manufacturing Information**

**Soldering**

For proper assembly, the component must be processed in accordance with the current revision of IPC/JEDEC standard J-STD-020. Failure to follow the recommended guidelines may cause permanent damage to the device resulting in impaired performance and/or a reduced lifetime expectancy.

**Washing**

Clare does not recommend ultrasonic cleaning or the use of chlorinated solvents.



**MECHANICAL DIMENSIONS**

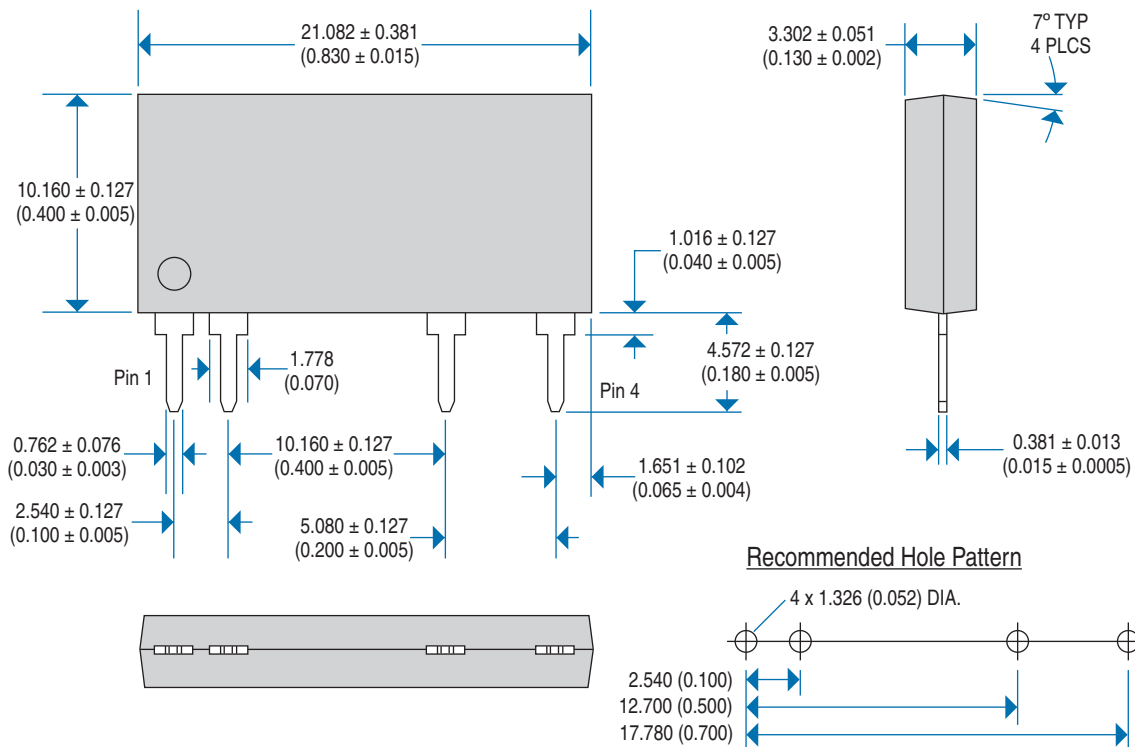

Dimensions  
mm  
(inches)

**Note:** Recommended hole size is based on the maximum cross-section diagonal measure of the pin plus 0.4mm (0.016).

**For additional information please visit our website at: [www.clare.com](http://www.clare.com)**

Clare, Inc. makes no representations or warranties with respect to the accuracy or completeness of the contents of this publication and reserves the right to make changes to specifications and product descriptions at any time without notice. Neither circuit patent licenses nor indemnity are expressed or implied. Except as set forth in Clare's Standard Terms and Conditions of Sale, Clare, Inc. assumes no liability whatsoever, and disclaims any express or implied warranty, relating to its products including, but not limited to, the implied warranty of merchantability, fitness for a particular purpose, or infringement of any intellectual property right.

The products described in this document are not designed, intended, authorized or warranted for use as components in systems intended for surgical implant into the body, or in other applications intended to support or sustain life, or where malfunction of Clare's product may result in direct physical harm, injury, or death to a person or severe property or environmental damage. Clare, Inc. reserves the right to discontinue or make changes to its products at any time without notice.